

VETERANS AFFAIRS AND REHABILITATION PATTERNS



**‘Salute, Serve and Celebrate
our Veterans, Military, their families
and our Communities’**

**AMERICAN LEGION AUXILIARY
DEPARTMENT OF WISCONSIN**

AMERICAN LEGION AUXILIARY DEPARTMENT OF WISCONSIN

The following patterns have been published for your use in making comfort items as well as favors to bring a little cheer into the lives of our hospitalized veterans.

Don't forget, the time spent making these items is to be recorded and reported.

You will notice that we have included numerous patterns for small favors, mainly to be made of plastic canvas. Our goal, again this year, is for all Medical facilities to have enough to distribute one to each hospitalized veteran at least once a month.

Unless otherwise noted, the comfort items are used at all VA Medical Centers and at the Wisconsin Veterans Homes.

If there is a problem with a pattern, contact the VA&R Chairman. Her phone and email address are listed in the Red Book.

Items with patterns specifying sizes, means this is the finished size unless otherwise noted.

BE SURE TO USE FLAME RETARDANT MATERIALS

PLEASE DO NOT SEND ANY ITEMS TO A FACILITY NOT REQUESTING THEM. IT IS COSTLY AND TIME COMSUMING TO SEND THEM ON TO A FACILITY THAT CAN USE THEM.

IF IN DOUBT CALL THE FACILITY TO CHECK.

**PLEASE REMEMBER TO FOLLOW DIRECTIONS AND
HAPPY CRAFTING.**

You may send the completed **QUARTERS FOR THE VETERAN** cards to the V.A. Medical Center of your choice – Madison, Milwaukee, King, Minneapolis, Oscar G. Johnson, Kenosha & Union Grove.

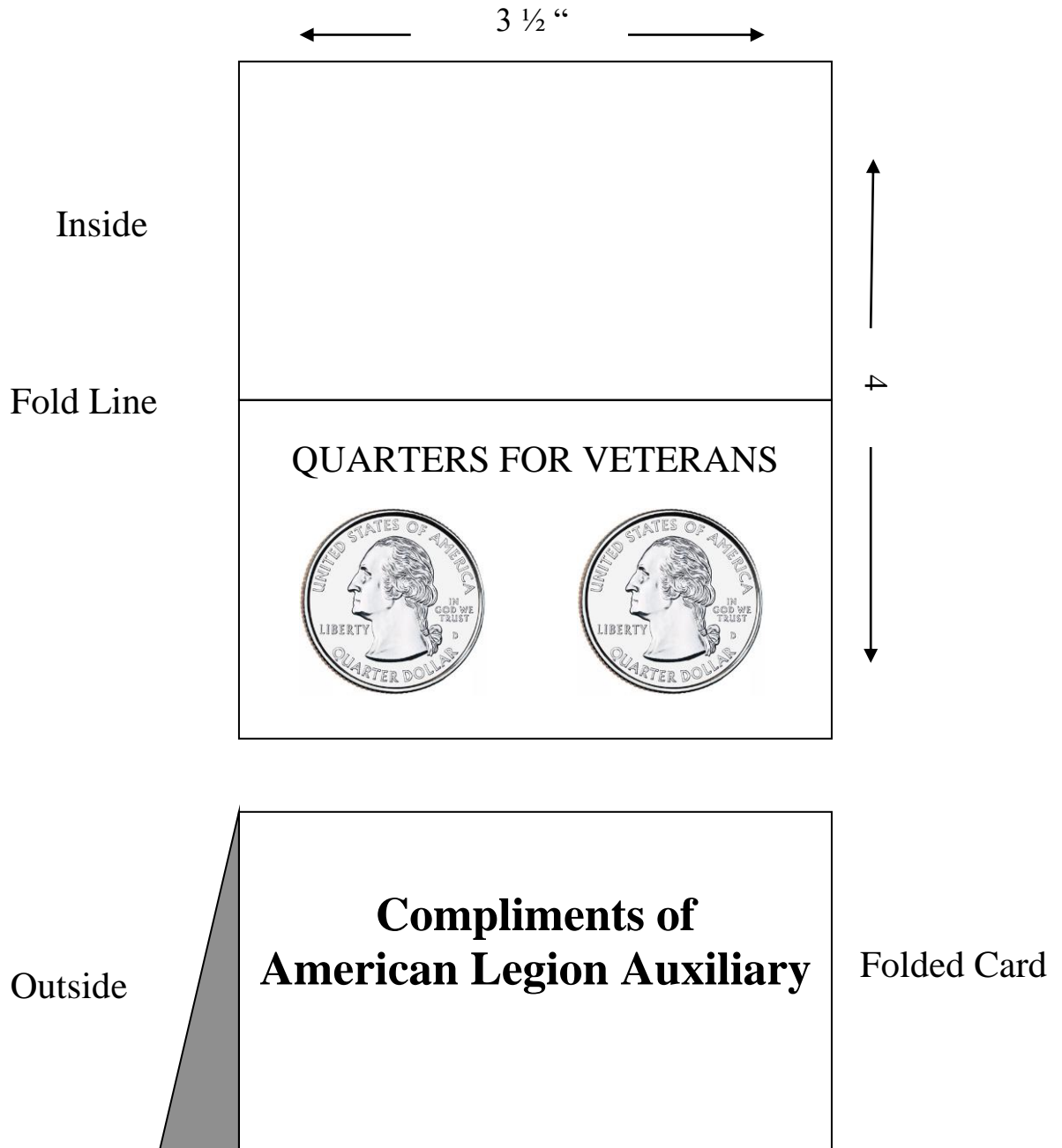

1. Use construction paper 4" x 3 1/2" – Fold in half on the 4" side
2. Use the above layouts as samples
3. Tape two quarters to each card as indicated
4. Put your Unit name and number on card

NOTE PADS

No Longer Needed at Zablocki

Needed: 8.5 x 11 white paper

Used greeting cards, Christmas cards & Note Cards (No religious pictures)

- Cut 8.5 x 11 sheets of paper into four sections.
- Make a template out of cardboard.
- Place template on best space of the greeting card and trace around it.
- Cut out picture.
- Count 15 sheets of white paper and put picture on top of sheets, staple either on top or on side depending on picture.

DO NOT have printing like Happy Birthday, etc showing. Get Well Soon would be the only exception. Also **DO NOT** use cards that have writing on back side of front. Put Unit stamp or write Unit # on the last sheet.

This is also a good project for Juniors members.

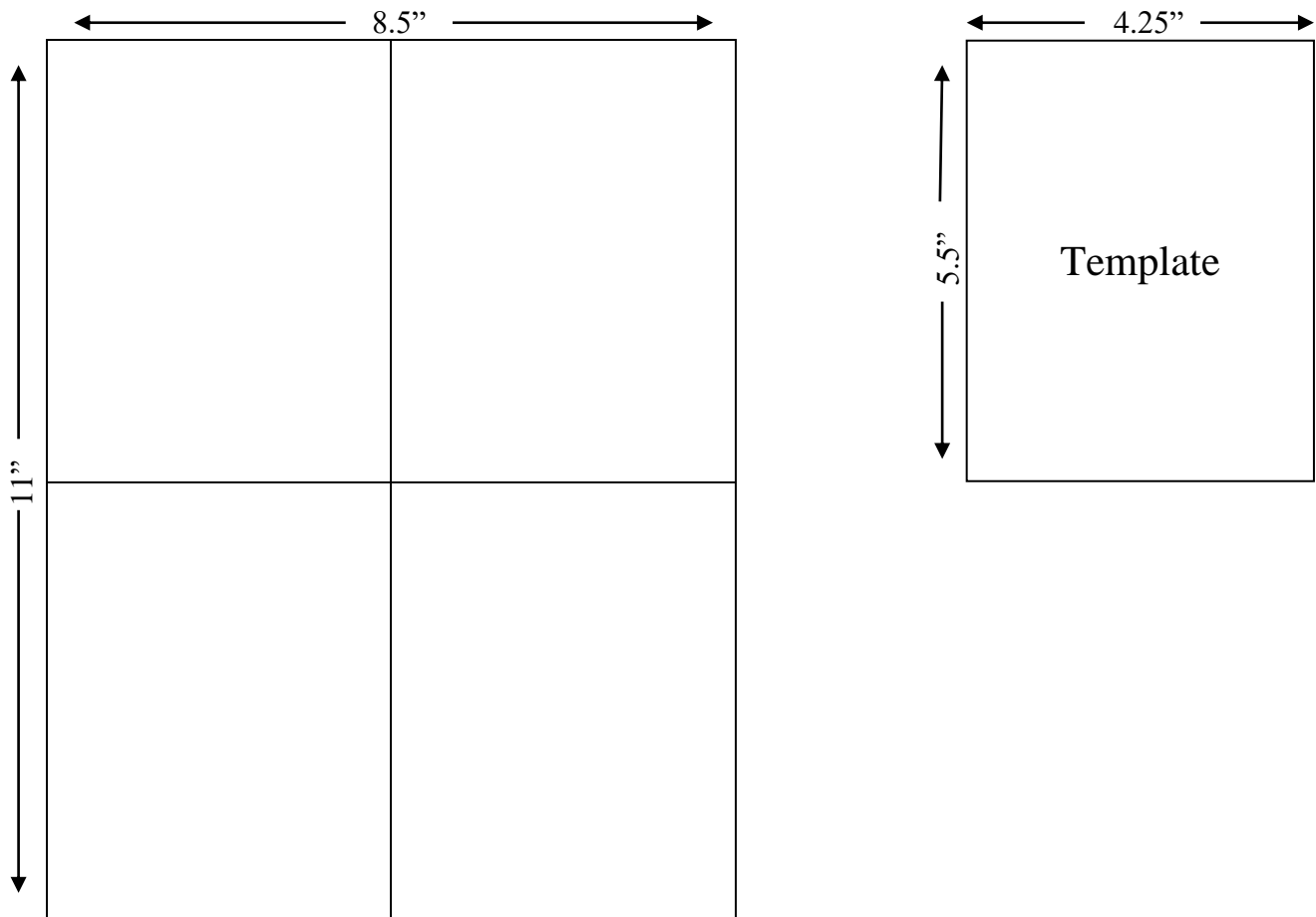

Add small
Velcro dot

2" x 6"

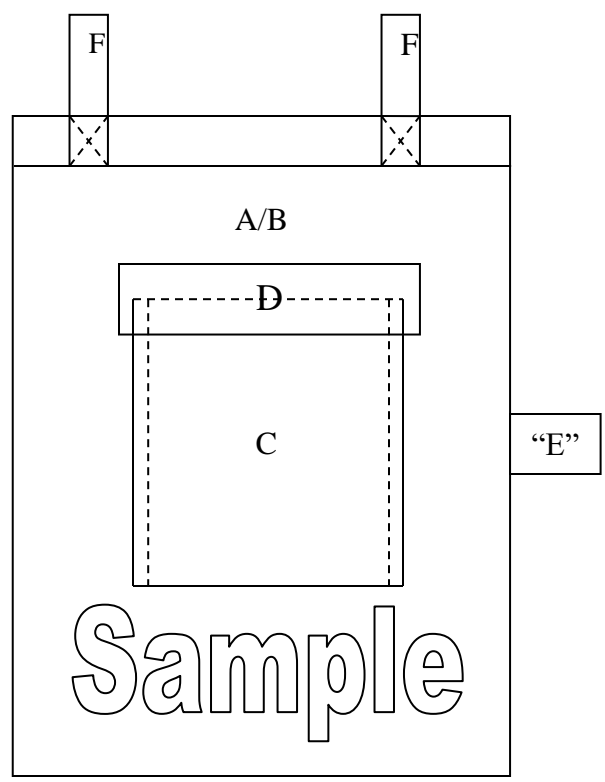
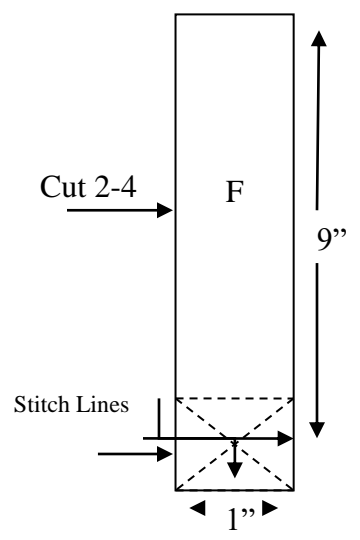
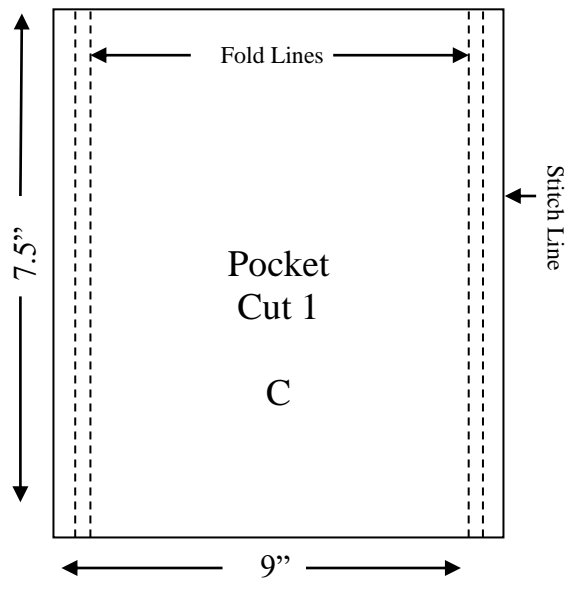
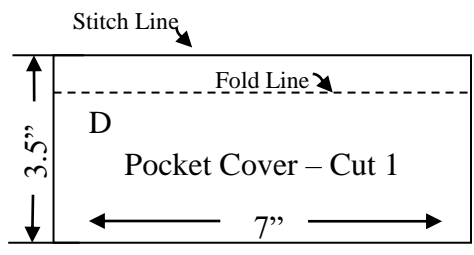
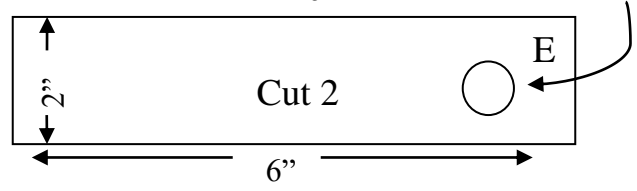
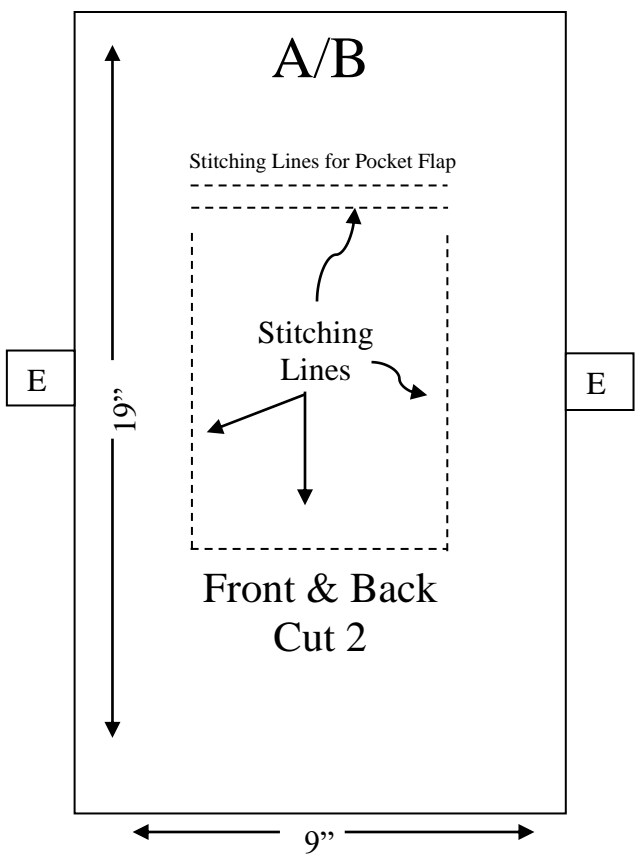

CRUTCH BAG

Needed at: Minneapolis,
Minnesota & V.A. Medical
Centers – Not needed at Tomah
V.A.

BOOTIE PATTERN

Needed at Oscar G. Johnson VA Medical Center
(Please use white flannel only)

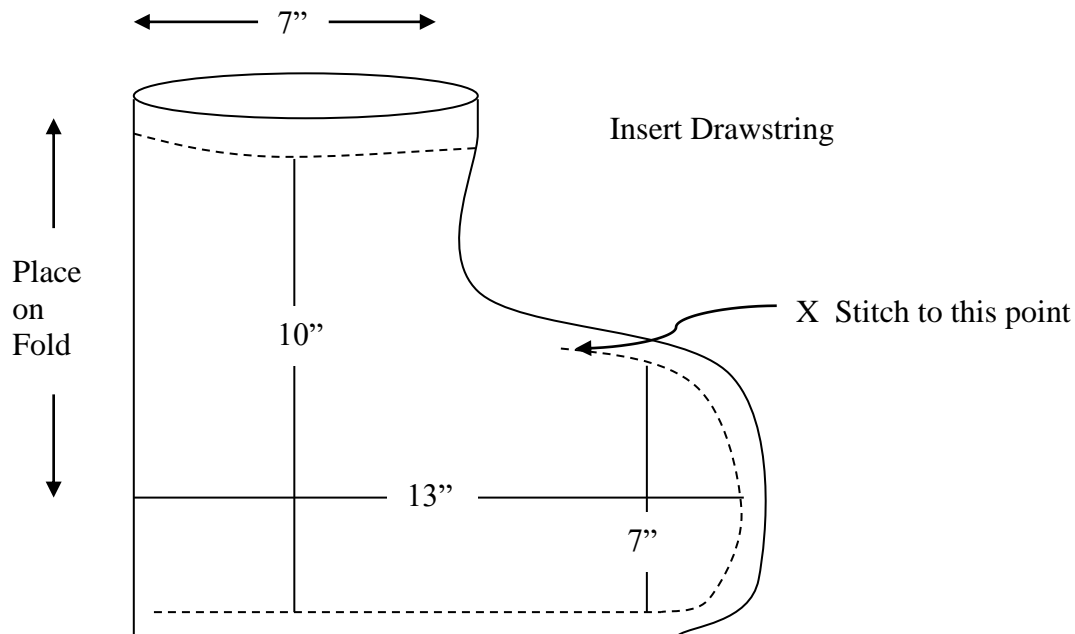

1. Cut 4 pieces to make 1 pair.
2. Open up two pieces – sew together across top – Fold Seam over – Finish side together.
3. Stitch from fold to point shown.
4. Turn one inside out and insert the other half inside to form one bootie. You will have a finished seam in and out.
5. Finish open edge – outside stitching – leave room for the drawstring opening.
6. On top of Bootie Stitch $\frac{3}{4}$ " from edge.
7. Make drawstring 2" x 20" or 36" - finish width of string – $\frac{1}{2}$ ".
8. Run drawstring through top – after string is in, sew in center on fold to keep in place – may also be tacked at heel seam.
9. Repeat as above for other two pieces.

CROCHETED SLIPPER-SOX WITH NON-SKID SOLES

Needed at: Oscar G. Johnson & Minneapolis Medical Centers
(Minneapolis will take the slipper socks without non-skid soles also.
Not purchased slipper socks)

MATERIALS:

4 oz. Skein 4 ply yarn
Crochet hook – size 11
Tapestry needle

MOLESKIN or similar leather – type material for 2 soles as per pattern. (Non-skid soles)

Loosely chain 50 st – cast on loosely

Row 1: DC in 4th st from hook; DC 43

Row 2 – 9 – CH 3; DC across making a total of 9 rows or approx. 5". Break yarn.

Begin in 9th DC from end. CH 3; DC in 27 DC.

Rows 2-7 – CH 3 and DC across.

On rows 8-9-10-11 decrease one DC on end of each row, ending with 24 DC on 11th row, and approx. 6"; making a total length of approx. 11". Break yarn.

FINISHING

With tapestry needle and double yarn, gather 12 DC in middle of beginning (44 st). Pull tightly together for heel, secure and proceed to sew up back.

With tapestry need and double yarn gather up the 24 DC for toe, tightly pul together, secure and proceed to sew up sock to within one row next to top of instep to allow enough room to easily get foot into slipper.

TO PREPARE SOLE FOR FINISHING

Cut soles from pattern and with small punch holes approx. 3/8" apart and in approx. 3/8". Work 2 SC in each hold around the sole. Place slipper on sole, pin front, back and sides and with tapestry needle and yarn sew sole unto slipper.

Crochet chain of yarn 29" long and lace from instep to top of slipper or lace tie around ankle and turn.



WHEELCHAIR BAG

Used to attach to wheelchair to hold personal items – can also be used on walkers.

MATERIAL: May be canvas or any other heavy type of material.

NO PLASTIC OR RUBBER MATERIAL

Please make to these specifications ONLY! (Other sizes are not usable)

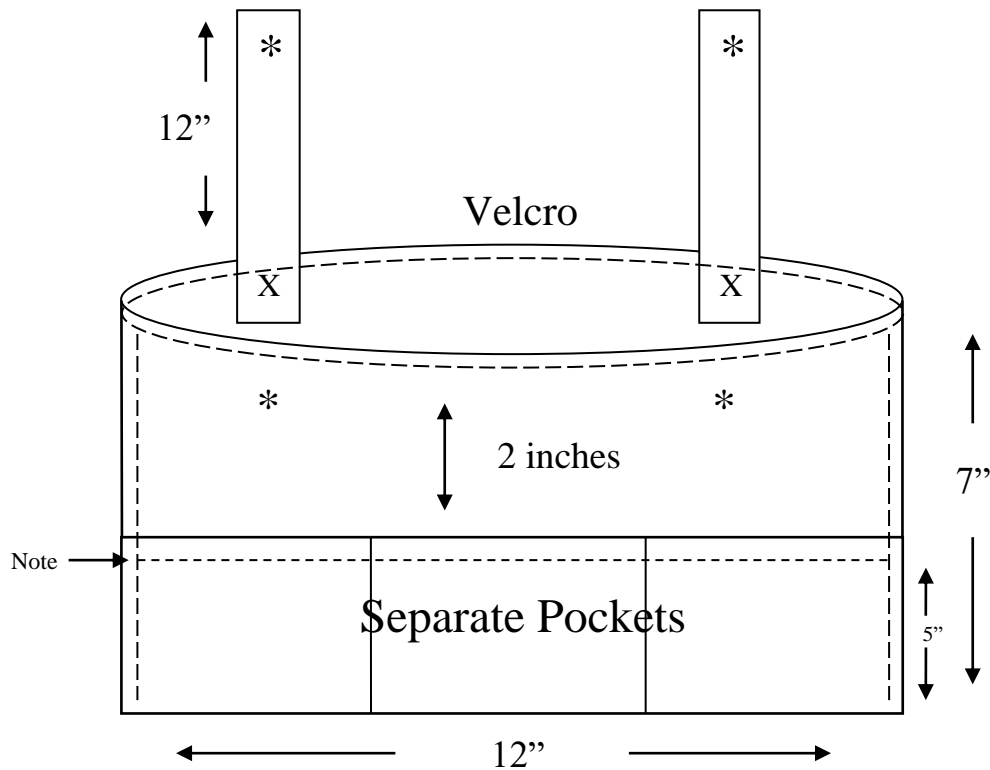

CONSTRUCTION:

- Finished size 7" x 12"
- 1" x 12" straps attached on side at the top
- Strap is made of a double thickness of material the same as the material used for the pocket.
- Seams on inside both sides and at the top of the pocket
- *Attach VELCRO fasteners to strap and top of pouch
- Note: Stitch separate pocket to front piece first then stitch down the divided pockets.

WHEEL CHAIR LAUNDRY BAG

Needed at Zablocki & Minneapolis V.A. Medical Centers

Inside pocket – 6” x10”

Use 1” wide elastic for handle

10” long elastic folded over to make handle

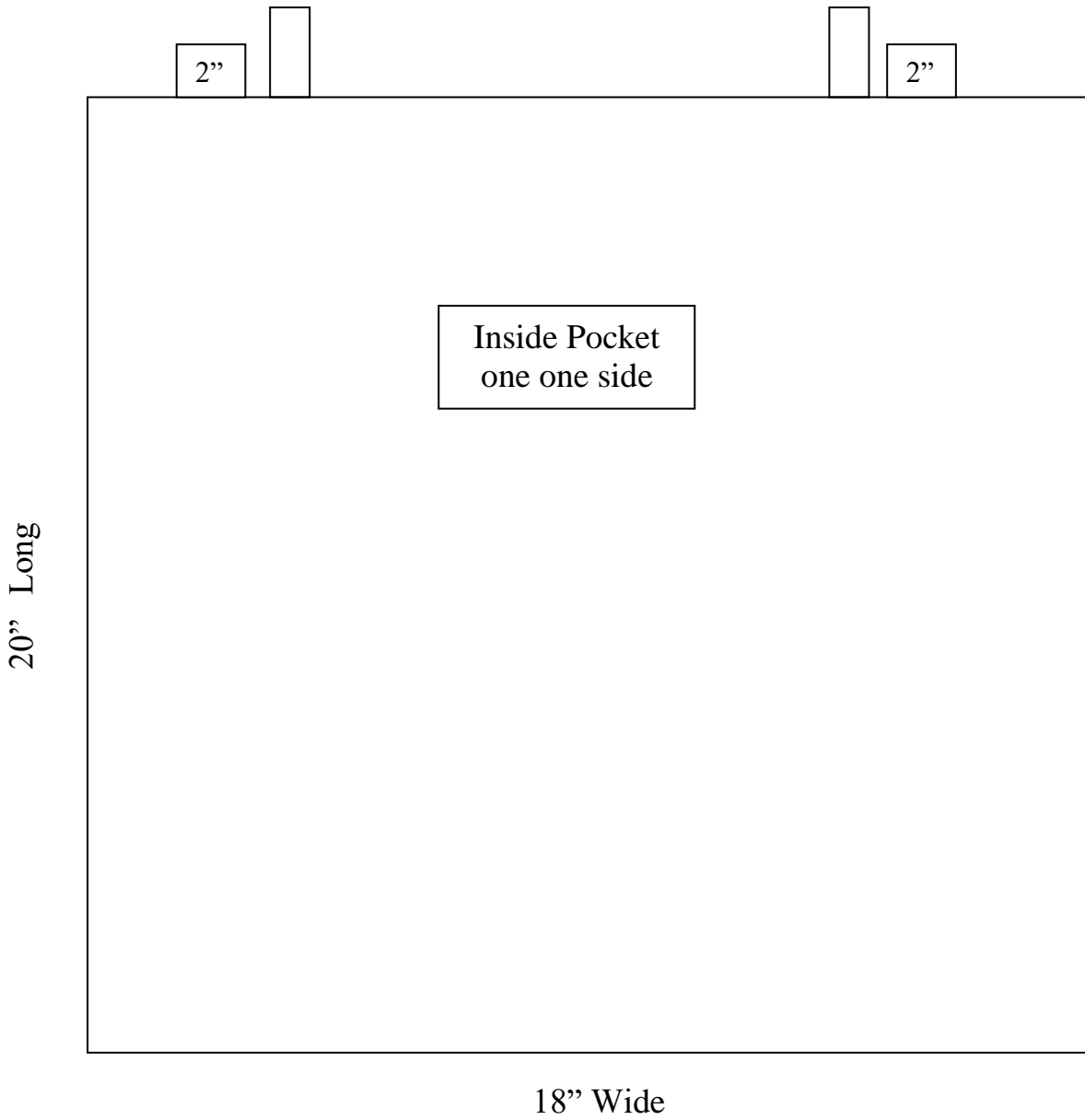

WHEEL CHAIR CHART BAG

Needed at Minneapolis VA Medical Center & King

Materials: anything durable such as denim, etc.

Handles are made of elastic. Sew handles in as you finish top. Larger (wider) wheel chairs should be Length = 18, Width = 23. Sew all handles to far edges. These slip over the wheel chair handles

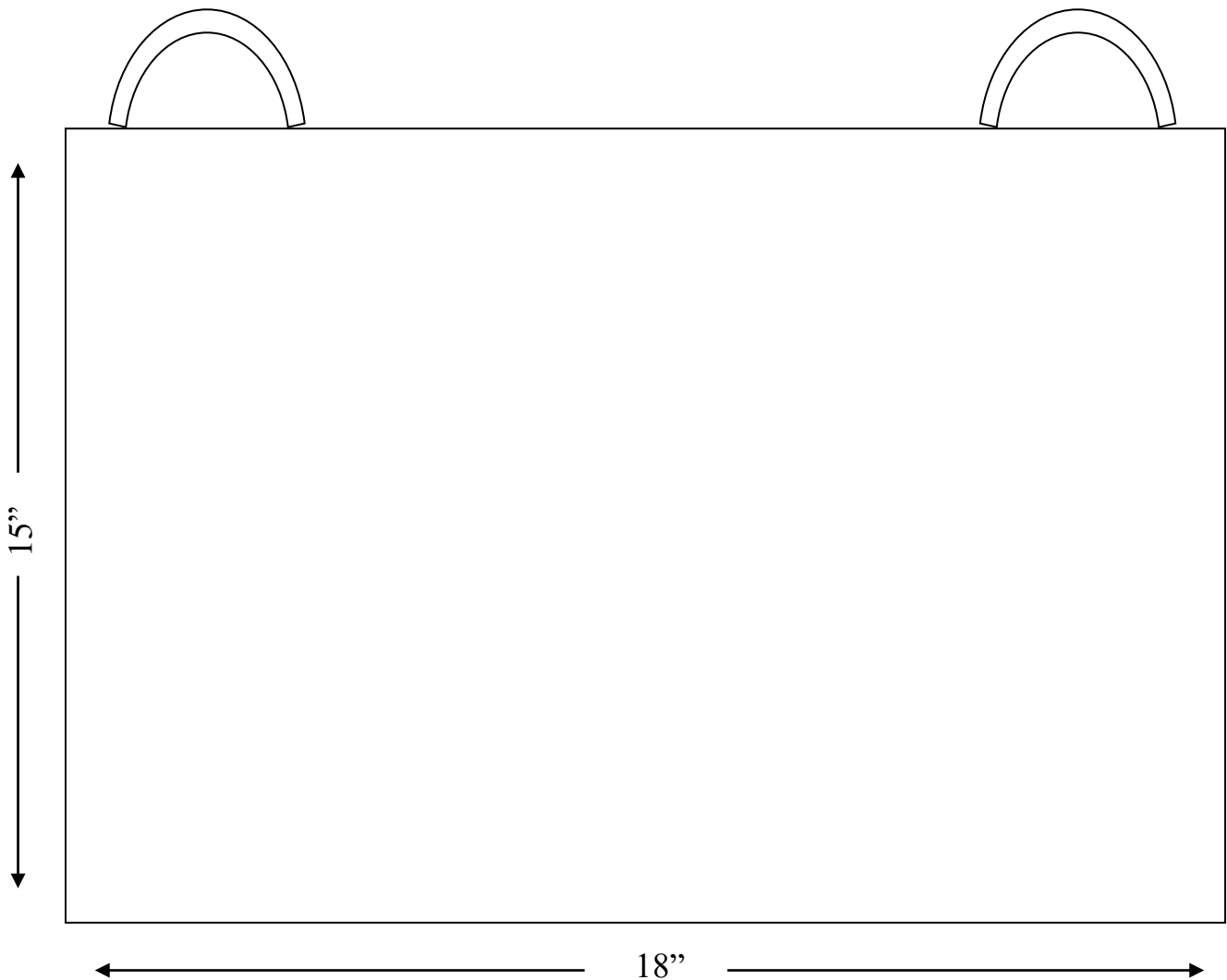

SHOPPING BAGS

(Needed at King only)

Finished size – 16” x 20” with 15” handles

Material – Heavy material (Denim Preferred)

Instructions:

Handles must be folded and sewed double for strength.

Handles should be placed 6” apart

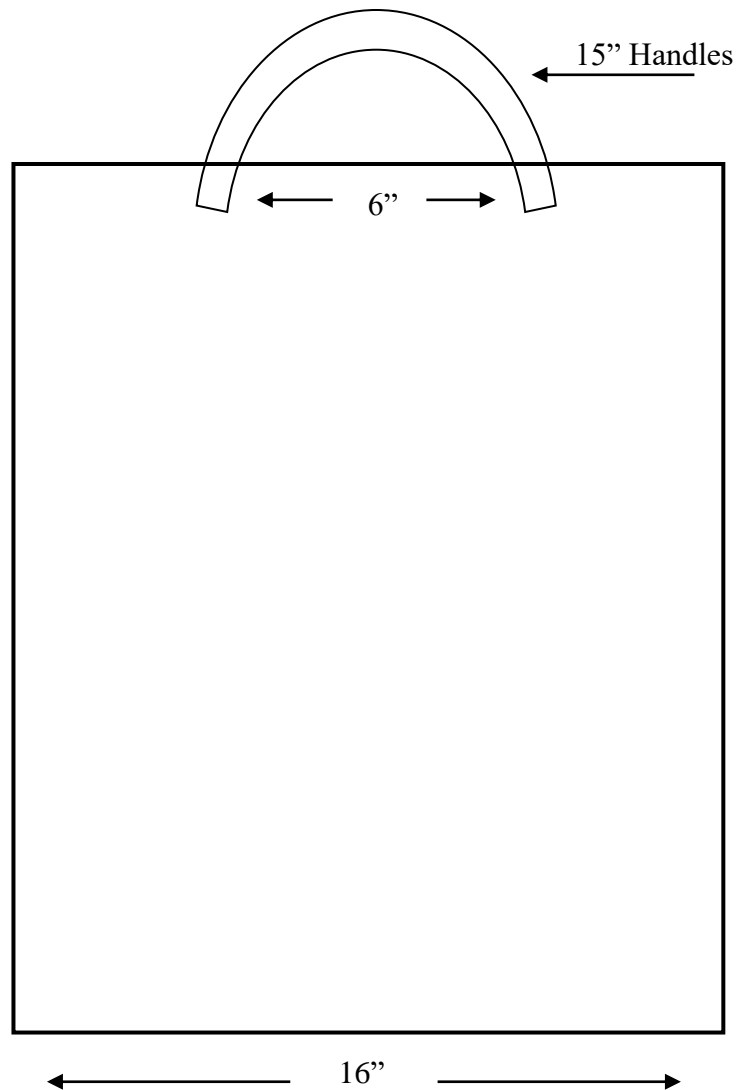

FOLEY BAG

MATERIAL: Can be made out of cotton or flannel material

- Cut Material 30" x 15"
- Cut facing to match 6" x 15"
- Turn hem up 2 ½ " to make 2" hem - sew
- Turn facing ½ for hem – sew
- Bring bottom up 11 ½ right side to right side
- Place facing on top right side to right side
- Sew ½ "seam all around
- Turn right sides out
- Sew Velcro on top and on hem line for closing
- Closes like a purse
- Finish side 12" x 14"

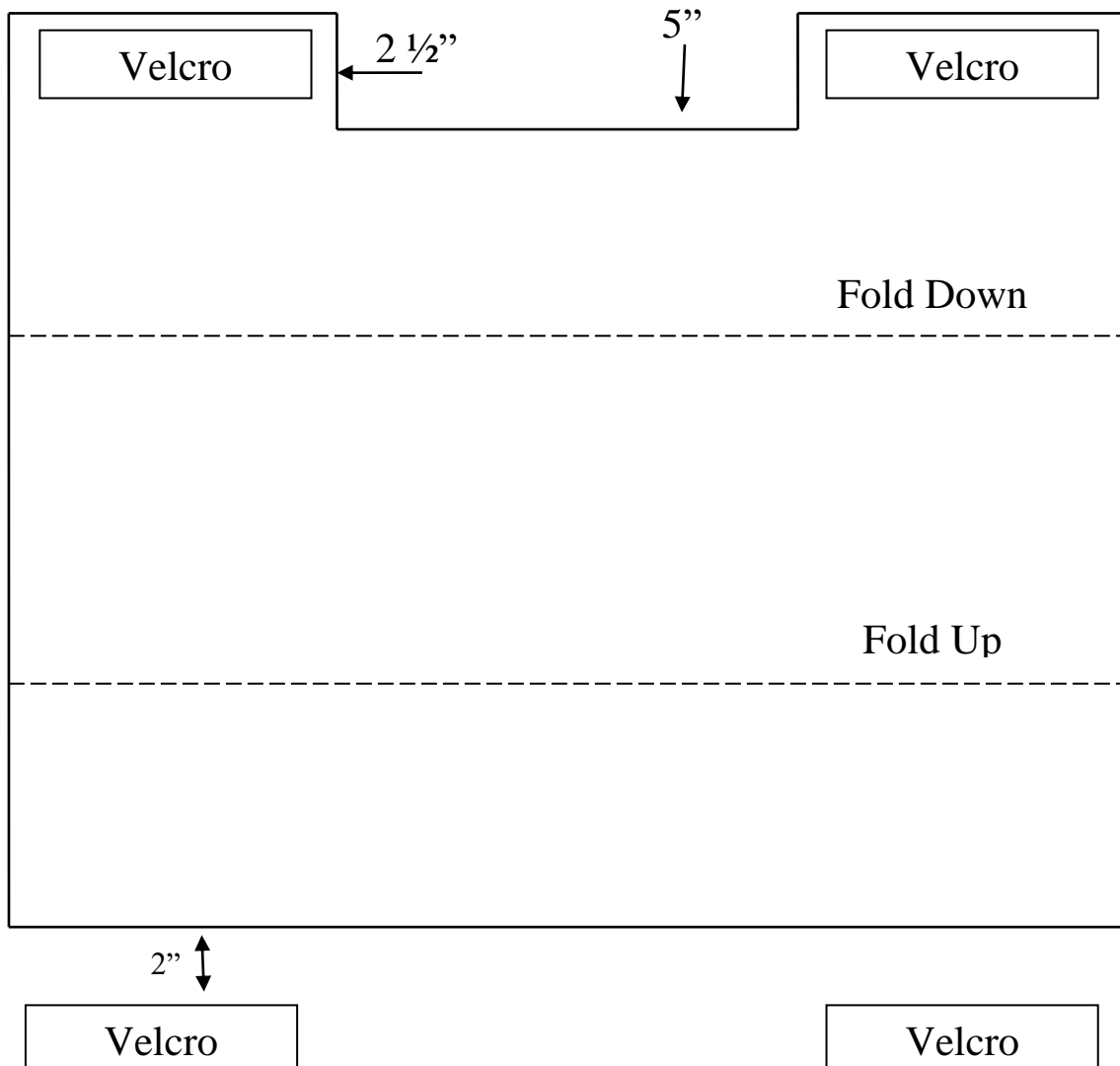

HEART MONITOR BAG
 FOR MINNEAPOLIS VETERANS HOSPITAL
 Check with other Hospitals - Not needed at Tomah

Make a Strap 32" long and 1/2" wide and attach it to the top.

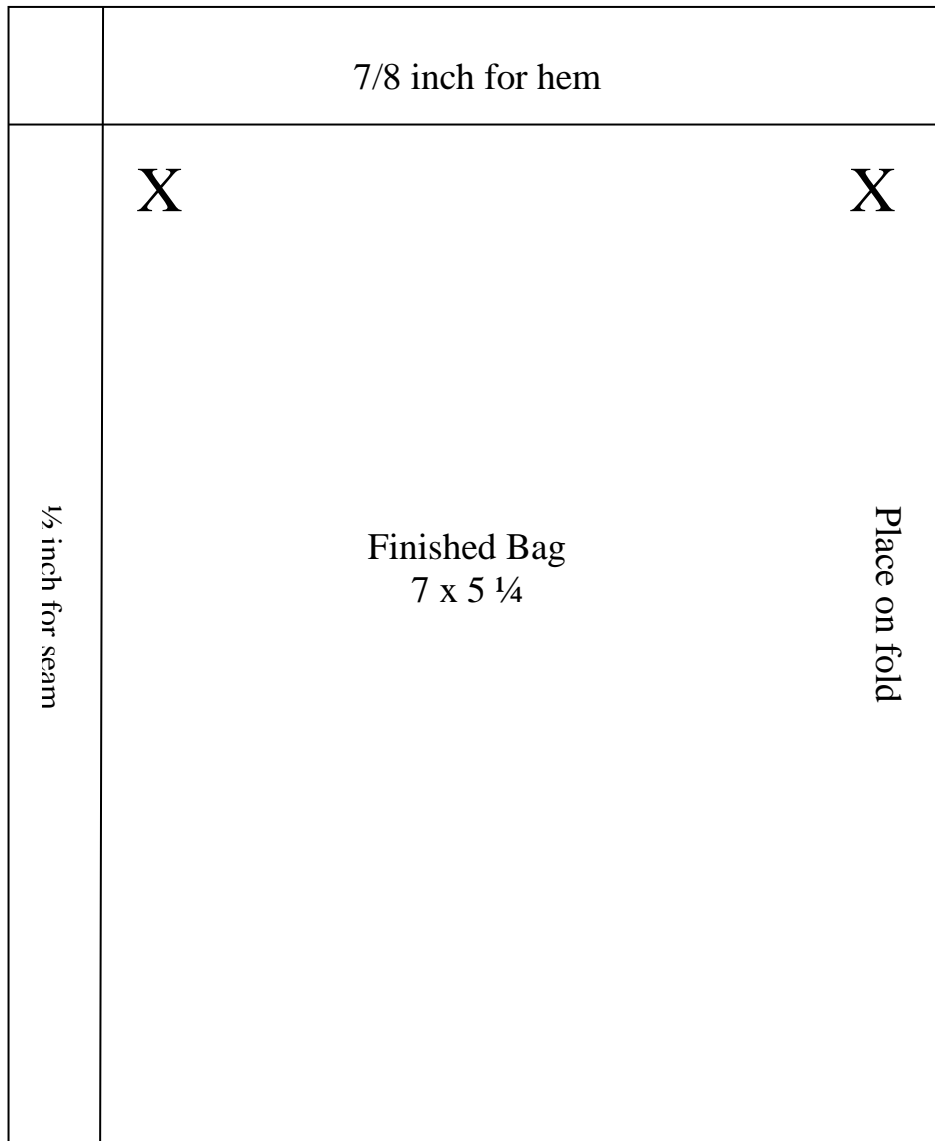

1/2 inch for seam

WELCOME TOTE

Need at Madison & Zablocki VA Medical Center

This “Welcome Tote” replaces the “Welcome Kit”. It has been proven that this tote is easier for the hospitalized patient to handle. It may be hung on a wheelchair or bed with no fear of contents spilling out.

MATERIALS: Good quality washable material (broadcloth, muslin, romona cloth, poplin or Indian head). **NO DENIM, LIGHT WEIGHT DRAPERY OR UPHOLSTERY MATERIALS.**

Color – Auxiliary blue but any dark color is accepted

Double drawstring of heavy tape, cord or shoe string of generous length

Please make to these specifications ONLY. (Other sizes are not usable)

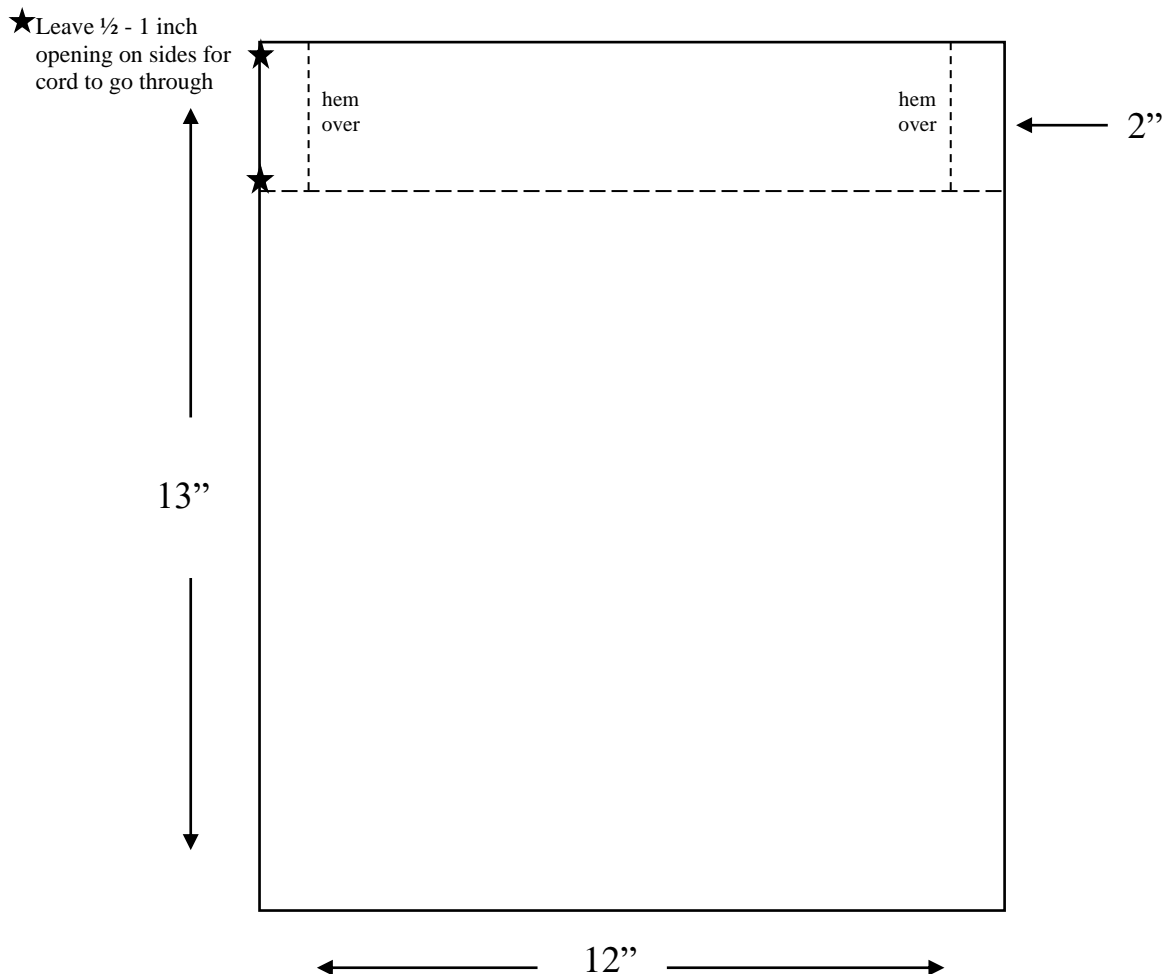

LAP ROBES / AFGHANS

MATERIAL: These must be made of washable material any color (Soft old denim)

Use either double thickness of material or a lining
Stitch or quilt to hold the 2 layers of material together or tack tie

Approximate size:
40" x 44" and 46" x 50" with ties on top end

This is used at Tomah & Minneapolis VA
Medical Centers

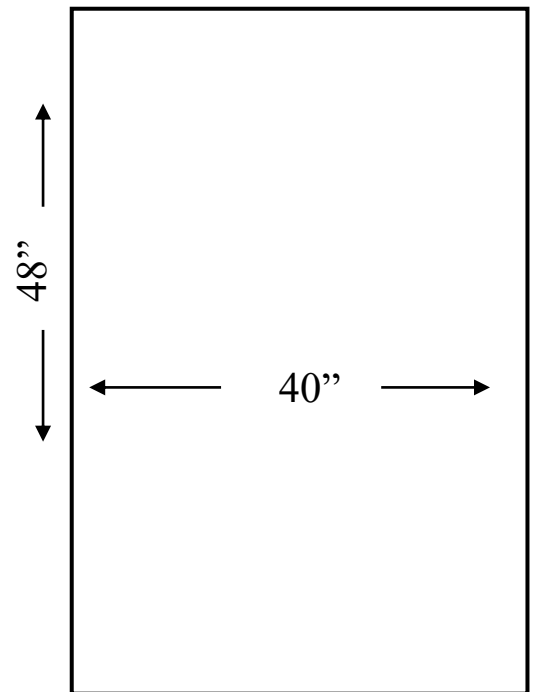

AFGHAN – Bed Size

5 x 6 ft. – This size is popular with the Veterans as it covers the entire bed

No ties on Afghans for Zablocki or Madison

May also be knitted or crocheted.

Be sure to make to size.

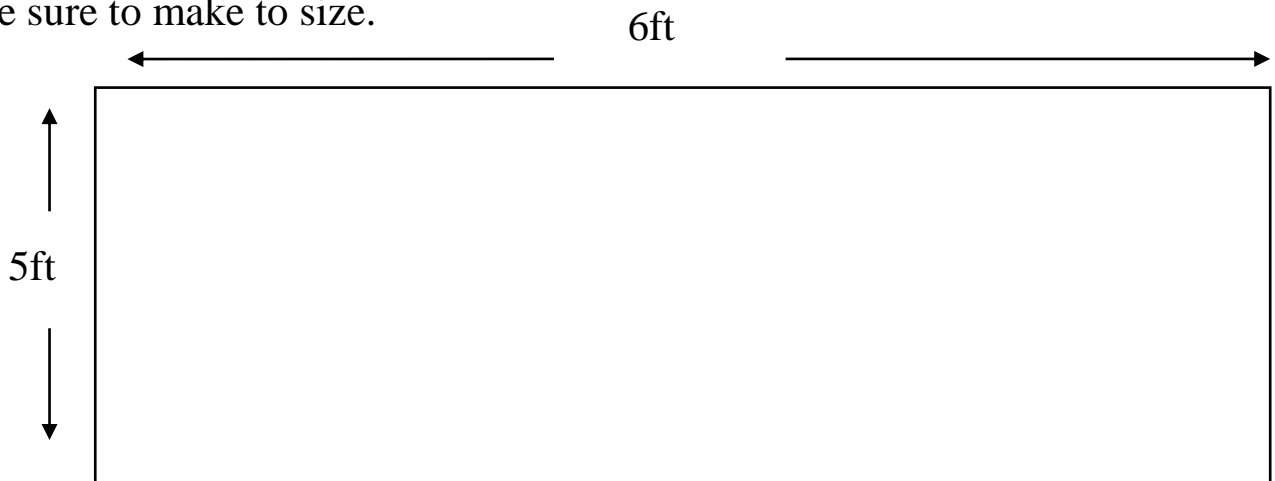

NO – SEW FLEECE BLANKET

58" x 72" – Blanket size includes fringe

2 yards main color (Fleece)

2 yards contrast color (Fleece)

1. Cut selvage edges off sides and straighten cut edges if needed
2. Lay main fabric on top of contrast fabric
3. Cut a 4" square from each of the corners
4. Cut 3 ½ " to 4" lengths every ½" to 5/8" along the edges
5. Tie the main and contrasting fringe together into a square knot (right over left, left over right). Continue tying all the fringes

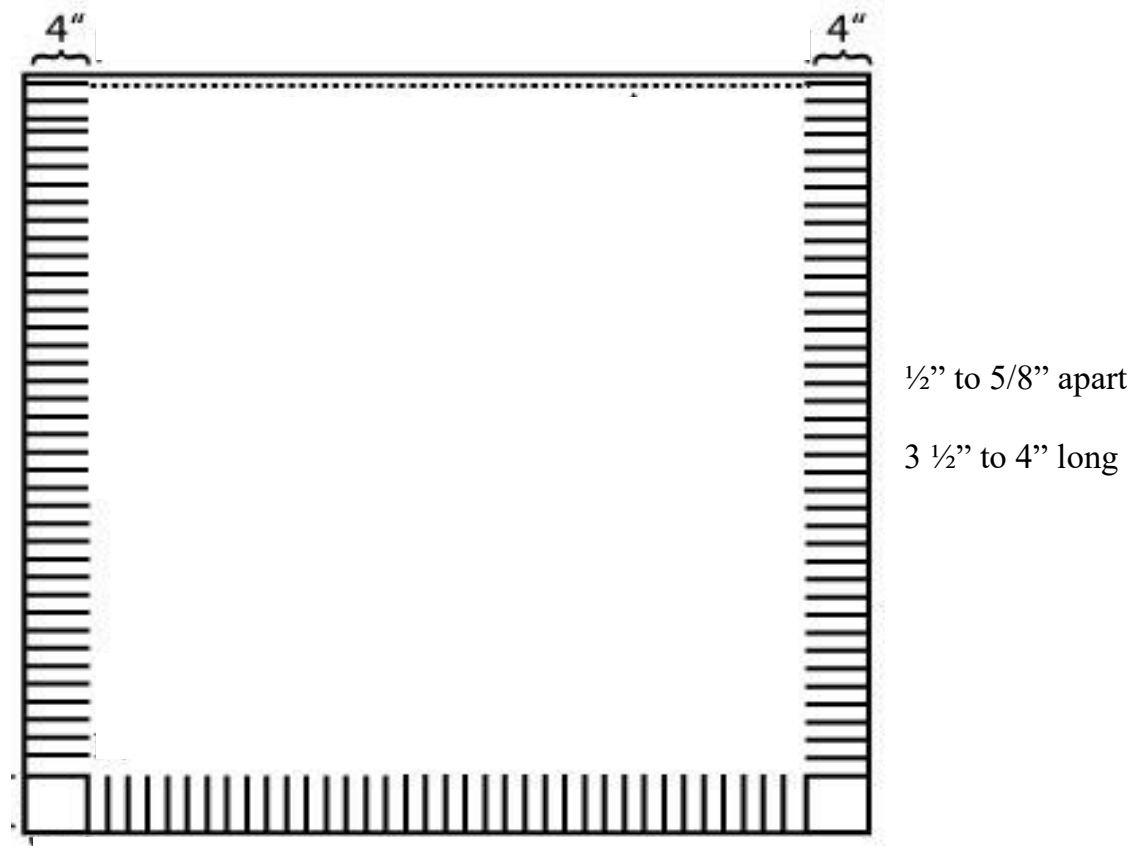

Now your blanket is complete ❖ Happy No-Sewing

BATH TOWEL BIBS

These bibs are cut out of your everyday bath towels. All raw edges need to be hemmed with a zigzag stitch and the neckline cut is more comfortable if it has binding around it. The neckline opening needs to be 10" as noted on the pattern. The depth should be approximately 12". Binding 1" to 1 1/2" wide.

Use polyester knit in bright colors for ties. The knit is much easier to tie and the center doesn't knot. Attach 20" ties.

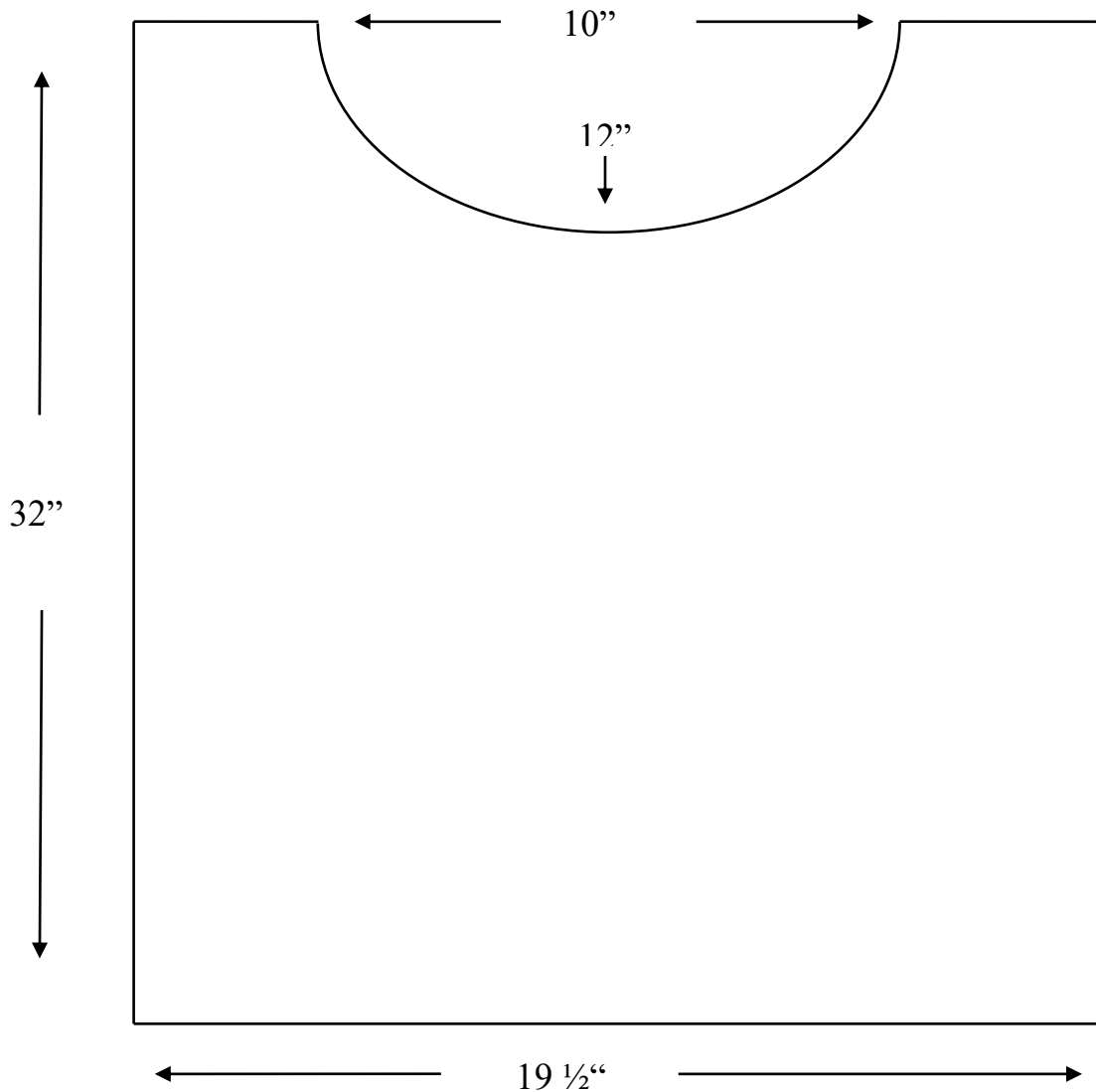

LAUNDRY BAG

(Needed at: Zablocki & Minneapolis V.A. Medical Centers & King)

Materials Needed: Good quality washable material, such as broadcloth, romona cloth, poplin indian head, duck or denim. **NO PLASTIC**

Color: Any color is accepted

Suggested Size: 2 ft x 2 ft

Tomah size – 2 ft x 2 ½ ft, double drawstring of heavy tape, cord or shoe string of generous length. 1 ½” heading at the top.

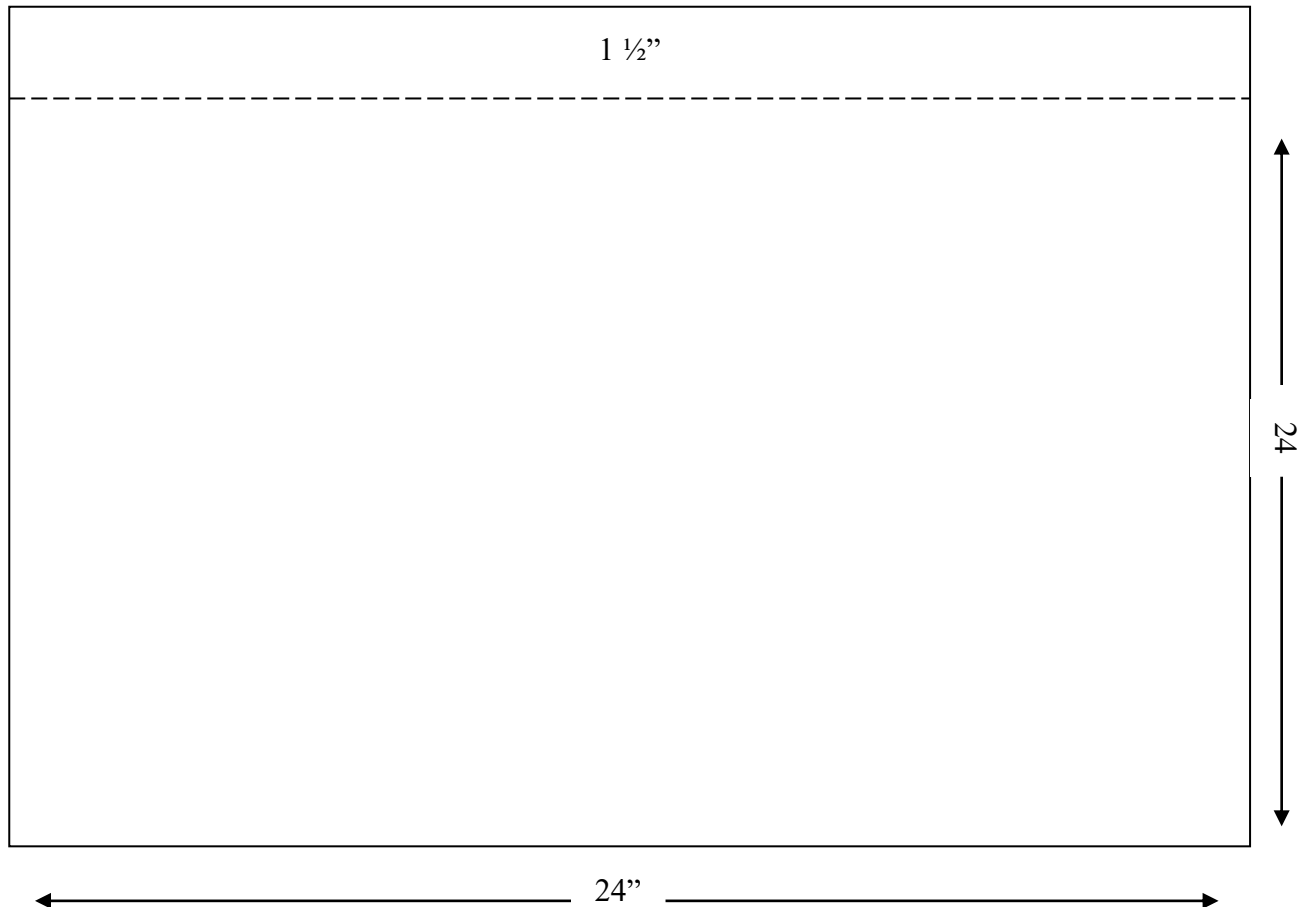

NEW BIB PATTERN (Union Grove only)

MATERIAL: Should be made of Terry Cloth or any other absorbent material.

- Width of bib is 19 ½”
- Length is 26” to neckline and 10 ½” above the neckline
- Use Velcro as fastener in the back

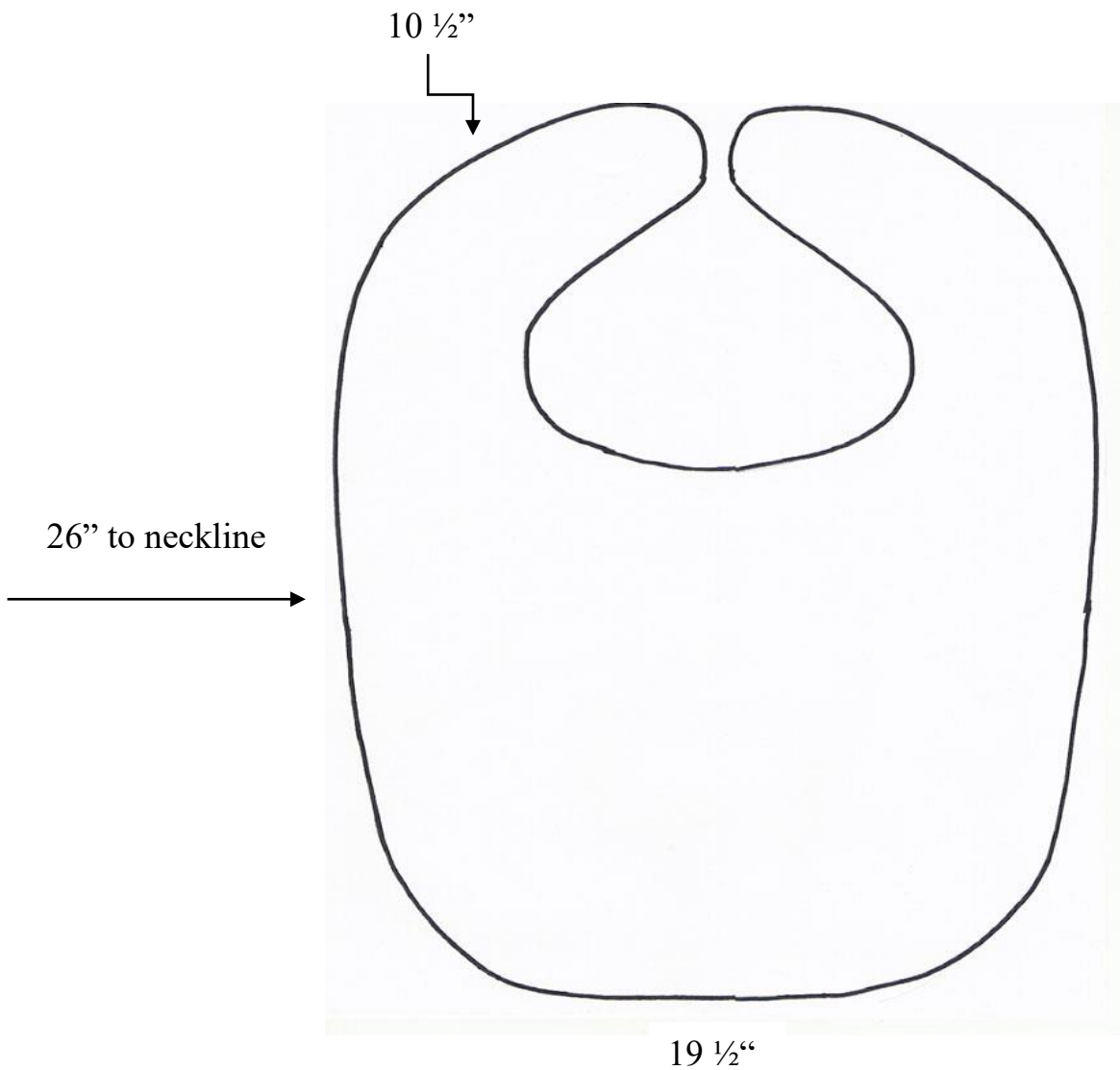

TRACHEOTOMY – STOMA COVER

Needed at: Most of the VA Medical Centers – Not at Zablocki or Tomah

Bib is made with a double thickness of Munsingwear white mesh fabric.

- Cut 12” circles
- Finish neck with T-shirt material cotton collar binding and sew velcro closure in the back
- 19” neck binding

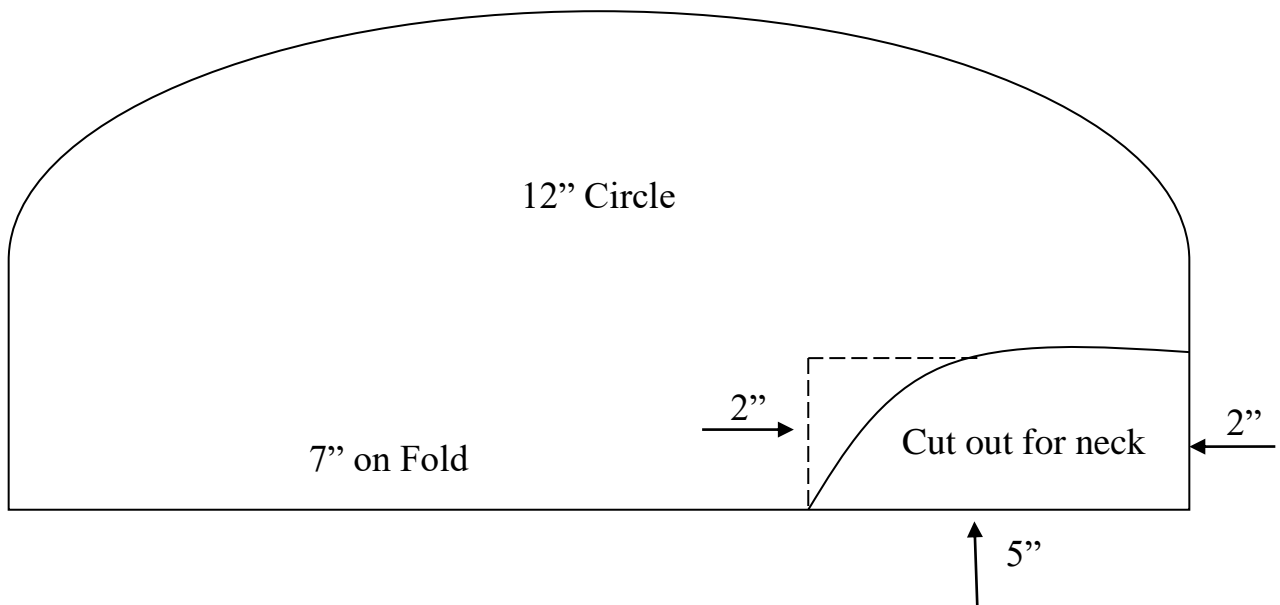

ALA BOOKMARK

Needed at Madison, Tomah, Minneapolis & Oscar G. Johnson VA Medical Centers

Materials:

Paper

1 3/8" X 6 1/2" Ribbon

American Legion Auxiliary Emblem

Directions:

Glue emblem to ribbon

Glue piece of paper with Unit # on

Laminate

Punch hole on top & put on a ribbon or decorative string

